

HCB-6000

1080p Analog HD Camera



Key Features

- Full HD resolution
- 0.09 Lux@F1.2 (Color), 0.009 Lux@F1.2 (B/W)
- Day & Night (ICR), WDR (120dB)
- SSNRIV, Motion detection
- Transmission distance max.500m
- Easy Installation (Plug & play), Dual power, RS-485

Compatible lenses



SLA-M2890DN

Compatible Accessories (Optional)



SHB-4200



SHB-4301HP



SHB-4200H



SHB-4300H1



STB-4150V

| Video | |
|----------------------------------|--|
| Imaging Device | 1/2.8" 2MP CMOS |
| Resolution | 1920x1080 |
| Max. Framerate | 30fps / 25fps(60Hz / 50Hz) |
| Min. Illumination | Color: 0.09Lux(F1.2, 1/30sec) BW: 0.009Lux(F1.2, 1/30sec) |
| Video Out | BNC(AHD / TVI / CVI / CVBS Selectable) |
| Video Transmission Distance | 500m(5C2V Coaxial Cable) 300m(5C2V Coaxial Cable) |
| Lens | |
| Focus Control | Manual |
| Lens Type | DC auto iris |
| Mount Type | C mount, CS mount |
| Operational | |
| Camera Title | Displayed up to 15 characters |
| Day & Night | Auto(ICR) |
| Backlight Compensation | BLC, HLC, WDR |
| Wide Dynamic Range | 120dB |
| Digital Noise Reduction | SSNRIV |
| Defog | Support |
| Motion Detection | 4ea |
| Privacy Masking | 8ea, rectangular zones |
| Gain Control | Low / Middle / High / Very High |
| White Balance | ATW / AWC / Manual / Indoor / Outdoor |
| Electronic Shutter Speed | 1 ~ 1/12,000sec |
| Video Rotation | H-Rev / V-Rev |
| Analytics | Motion detection |
| Serial Interface | RS-485(Samsung-T, Pelco-D/P, Panasonic, Bosch, AD, GE, Vicon, Honeywell) |
| Alarm I/O | MD output 1ea, External D/N 1ea |
| Alarm Triggers | Analytics |
| Alarm Events | Alarm output |
| Coaxial Protocol | ACP(AHD Coax Protocol), TCP(TVI Coax Protocol), CCP(CVI Coax Protocol) CVBS: Pelco-C(Coaxitron) |
| Environmental & Electrical | |
| Operating Temperature / Humidity | -10°C ~ +55°C(+14°F ~ +131°F) / Less than 90% RH |
| Input Voltage | 24VAC, 12VDC |
| Power Consumption | Max 3.5W |
| Mechanical | |
| Color / Material | Black / Aluminum, Ivory / Plastic |

Product Dimensions / Weight

68.4(W)×59.6(H)×92.7(D)mm(2.69×2.35×3.65"), 186g(0.41 lb)

- The latest product information / specification can be found at hanwha-security.com
- Design and specifications are subject to change without notice.
- Wisenet is the proprietary brand of Hanwha Techwin, formerly known as Samsung Techwin.

| NO | PART NAME | CODE NO. | MATERIAL | Q'TY | REMARK |
|----|-----------|----------|----------|------|--------|
| 1 | | | | | |

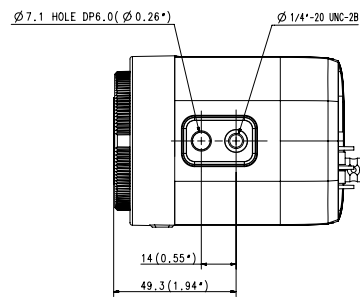
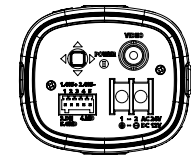
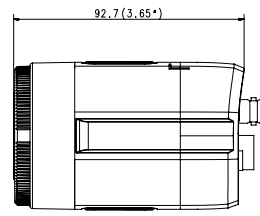
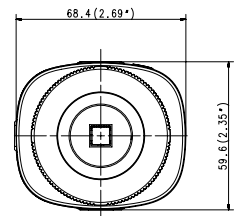
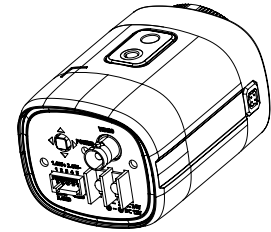
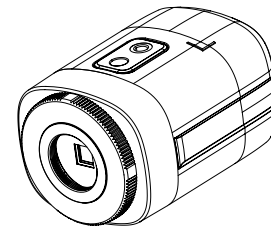
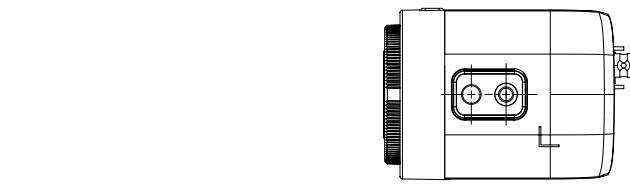

CHANGE

| UNIT | DATE | DESIGN | CHECK | APPROVAL | PART NAME | |
|----------------|------|----------|----------|----------|------------|---------------|
| | | HTW | - | - | | - |
| SCALE | 1/1 | 17.07.26 | 17.07.26 | 17.07.26 | MODEL NAME | HCB-6000/7000 |
| HANHWA TECHWIN | | | | | CODE NO. | 057837 |